



INSTALLATION GUIDE

COMPOSITE DECKING



CONTENTS

STORAGE & HANDLING	03
SAFETY & USE	04
TOOLS	05
CALCULATING BOARDS	06
DECKING COMPONENTS + ACCESSORIES	07
PRE INSTALLATION NOTES	09
FALLS AND GRADIENTS	10
INSTALLATION OF SUBSTRUCTURE - TIMBER	11
INSTALLATION OF SUBSTRUCTURE - ALUMINIUM OR PLASTIC	12
INSTALLATION	13
CLEANING AND CARE	33
EXPANSION GAP TABLE	34
REMOVING A BOARD	35

STORAGE & HANDLING

Whilst our composite materials are highly durable we do recommend you follow the below guidelines for storage, handling and installing, to ensure products are kept in the best possible condition.

STORAGE

- Materials should be stored under cover in shade, and protected from weather until ready to install.
- Materials should be covered and kept dry until ready to install to ensure a clean surface. Products should not be stored outside and or covered with plastic sheeting.
- All composite products should be stored supported above the ground at 500mm intervals on a flat clean surface. Supporting battens used in storage should align through the stack to equally transfer the load.
- Boards must be stacked on top of each other
- Where multiple pallets are delivered these should not be stacked higher than 3m per stack.
- Ecoscape will not be held responsible for issues that arise from poor storage.

HANDLING

- Decking materials should be placed and not dumped when unloading. Boards should be lifted and set down with care to avoid damage. Do not slide boards over one another.
- Decking boards should be carried in the middle and on their edge for best support when moving.
- During installation, avoid sliding or dragging any equipment across the board surface to avoid tarnishing the surface
- The surface of the decking boards should be kept free of construction debris and material to prevent damage to the boards. As with all sites, surfaces should be kept clean and tidy for the best installation outcome.

SAFETY & USE

Prior to installing any composite system we recommended that you consult local building regulations for any special requirements or restrictions that may apply. The illustrations and accompanying instructions in this guide are for illustrative purposes to provide a typical installation scenario, and do not replace the advise of a licensed professional in the field.

SAFETY

- Personal Protection Equipment (PPE) should be worn at all times (COSHH Assessment summary available). When cutting and installing boards it is advised to wear gloves, protective eye wear, a dust mask, long sleeves and trousers.

- Dry and windy environments may result in a naturally occurring static build-up in composite products. The level of static build up will not cause personal injury.

- All composite decking boards **MUST** be installed on a substructure to allow adequate air flow beneath - this prevents any excessive water absorption. Boards cannot be laid directly onto a flat surface. A minimum of 25mm clearance beneath the decking should be provided to allow adequate drainage and drying.

- Excessive heat may be felt on the surface of the composite decking products from external sources such as reflection of sunlight from Low-E glass. This may cause an unusual heat build-up on any exterior surfaces. Excessive heat exposure may cause: boards to sag or warp, expansion/ contraction at increased levels, accelerated weathering, and in extreme circumstances melt the board surface.
Note - A rise to such adverse levels is deemed extremely unlikely in the UK due to the stable climate.

USE

- Standard woodworking tools can be used to install our composite products. When using a chop saw we would recommend a 60T+ Multipurpose Aluminium blade for maximum efficiency and neatness on cuts.

- We recommend the B+M screws provided with the T-Clips for installation of the boards - using any other screw system will invalidate the installation warranty. All fixings should be fastened at 90 degrees to the decking system.

- Before starting, It is imperative to plan your decking to ensure the best looking layout is achieved. We would recommend paying particular attention to fixed elements such as door thresholds, gutter outfalls and walls in order to determine the optimal laying pattern and starting position of the first boards.

- Composite Decking Boards are not intended for use as primary load-bearing members. I.e. cantilevered structures, supports, beams or stringers.

- Boards must be supported by a compliant substructure at ≤ 400 mm centres and absolutely **CANNOT** be installed onto existing decking boards.

TOOLS

RECOMMENDED TOOLS TO INSTALL COMPOSITE DECKING

Standard woodworking tools can be used when working with B+M Decking. If you are unsure on how to use any tool, please consult the tool's manufacturer's user manual.

Circular Saw - we recommend a 60T+ Aluminium / laminate multipurpose blade to achieve the cleanest cuts.

Mitre Saw extremely useful

Jig Saw

Hand Drill

3mm and countersink drill bits (SmartBit countersink tool available)

Tape Measure

Set Square

Stringline

Spirit Level

Protective eye wear and relevant Personal Protection Equipment (PPE)

Pencil

CALCULATING BOARDS

To determine how much HomeDeck Decking material will be required, you can either use detailed plans or follow the method below.

Alternatively, feel free to speak to one of our technical experts on 0845 9011 988.

1. Start by measuring the width and length of your proposed decking area(s)
2. Plan which direction to lay your decking
3. If the boards are laid lengthways, to find the number of board rows, divide the deck width by the width of the boards, plus a 5mm spacing per board (allows for the hidden T-Clip):

Ecoscape boards are available in the following sizes:

Clarity - 25mm (H) x 150mm (W) x 2900mm or 4800mm (L)

Forma - 25mm (H) x 150mm (W) x 2900mm or 4800mm (L)

For example, for a decked area 3.1m Wide x 6m Long, boards (150 x 25mm) with 5mm hidden fasteners:

$3.1\text{m width} / (0.150\text{m} + 0.005\text{m}) = 20$ boards wide

4. Now multiply the length of the deck by the number of boards wide (given above). This gives you the total linear meters of deck boards required:

$6\text{m length} \times 20$ boards wide = 120 linear meters

5. Next, divide the total linear meters of decking by the length of board being used:

120 linear meters / 2.9m board length = 41.3 lengths of 2.9m decking boards

6. Finally, multiply the number of total boards by 1.05 to include for 5% wastage:

$41.3 \times 1.05 = 43.365$ or 44 Boards.

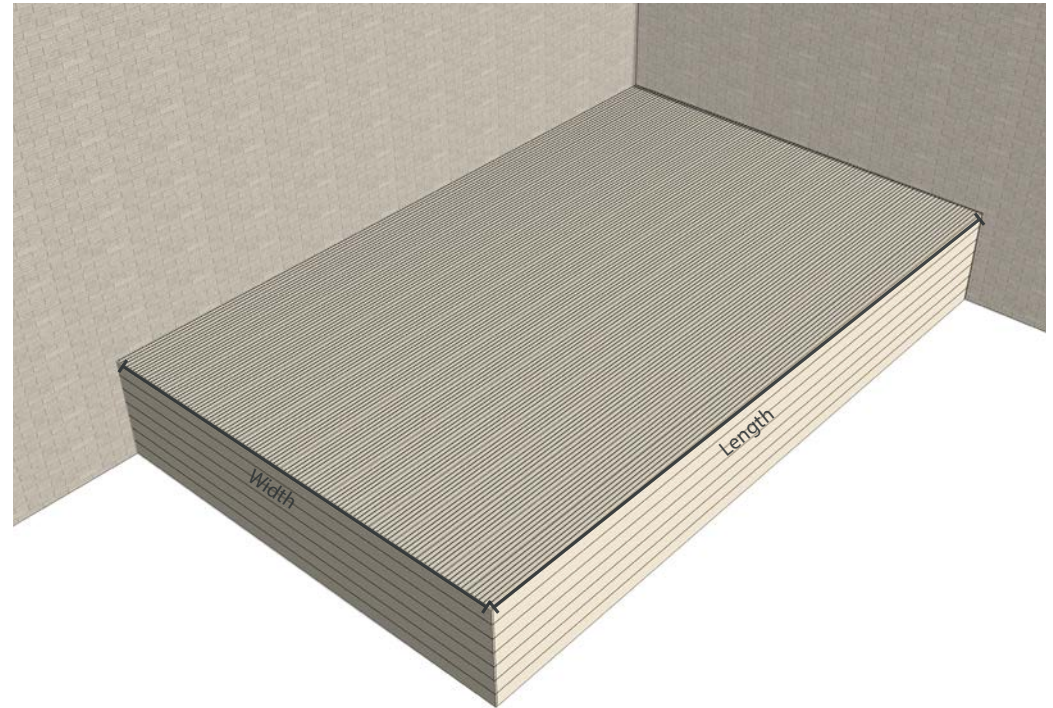

The same method of calculation can be used to work out the number of boards required to the vertical fascia's to the deck.

PRE INSTALLATION NOTES

Decking areas can take many forms and scales of complexity. The following guide portrays the steps to install the basic board system and side trim. The approach shown can be used to develop terraces and step details however these will require further planning and consideration.

The diagrams shown use a external grade timber sub-frame on which to fix the decking. Boards can also be fixed onto aluminium or solid plastic frames. Ecoscape are able to offer support with and design approaches which vary from that shown here.

*** Please refer to the table on page 34 when installing the deck boards to determine the gap (mm) between boards and adjacent structures.

Acclimating the composite boards least two days prior to installation is recommended. This will help prevent unwanted shrinkage issues seen during and after installation.



TYPICAL INSTALLATION: DECKING AREA ADJACENT TO HOUSE

FALLS AND GRADIENTS

Whilst not absolutely necessary, it is recommended that composite decking boards are installed at a 1% gradient.

Boards laid parallel to the direction of fall will encourage water to shed via the pre-formed groves in the boards, and so further reducing the risk of slipping when wet.

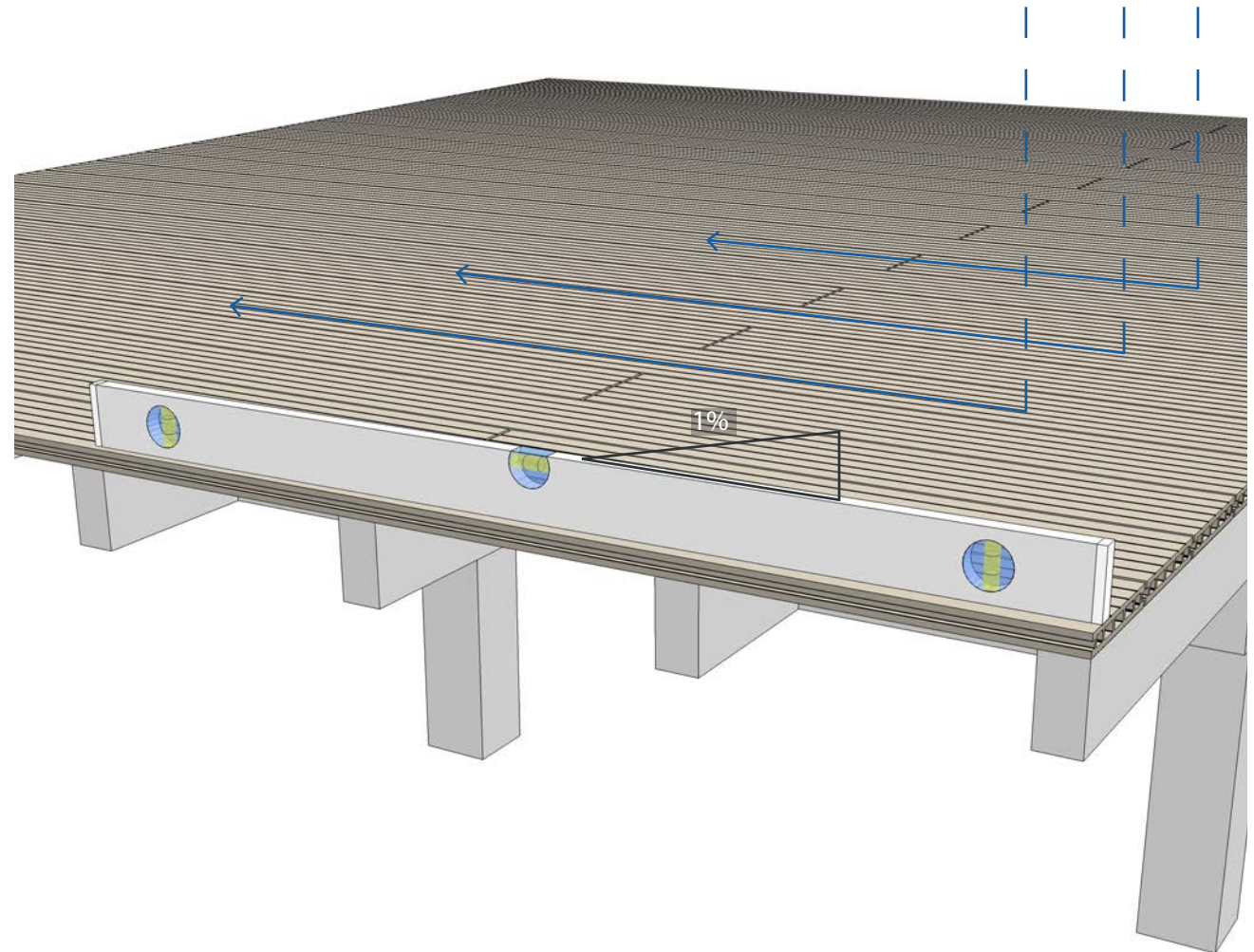

INSTALLATION OF SUBSTRUCTURE

TIMBER JOISTS

DECKING JOIST LAYOUT:

Joists should be fixed to a secure post in a concrete foundation or similar.

Ecoscape are unable to accept any liability for the installation of inadequate sub-frames. The contractor should ensure the frame is adequately prepared.

JOIST SPECIFICATION:

- Decking can be fixed to pressure treated softwood timber joists (Grade C16 - EN14081 or similar) or composite / aluminium joists depending on design requirements.
- Joists should be fixed into position at 400mm centres using suitable A4 stainless steel countersunk wood/ masonry screws. All joists need to be fixed in a minimum of 3 places.

TYPICAL TIMBER SUB-FRAME

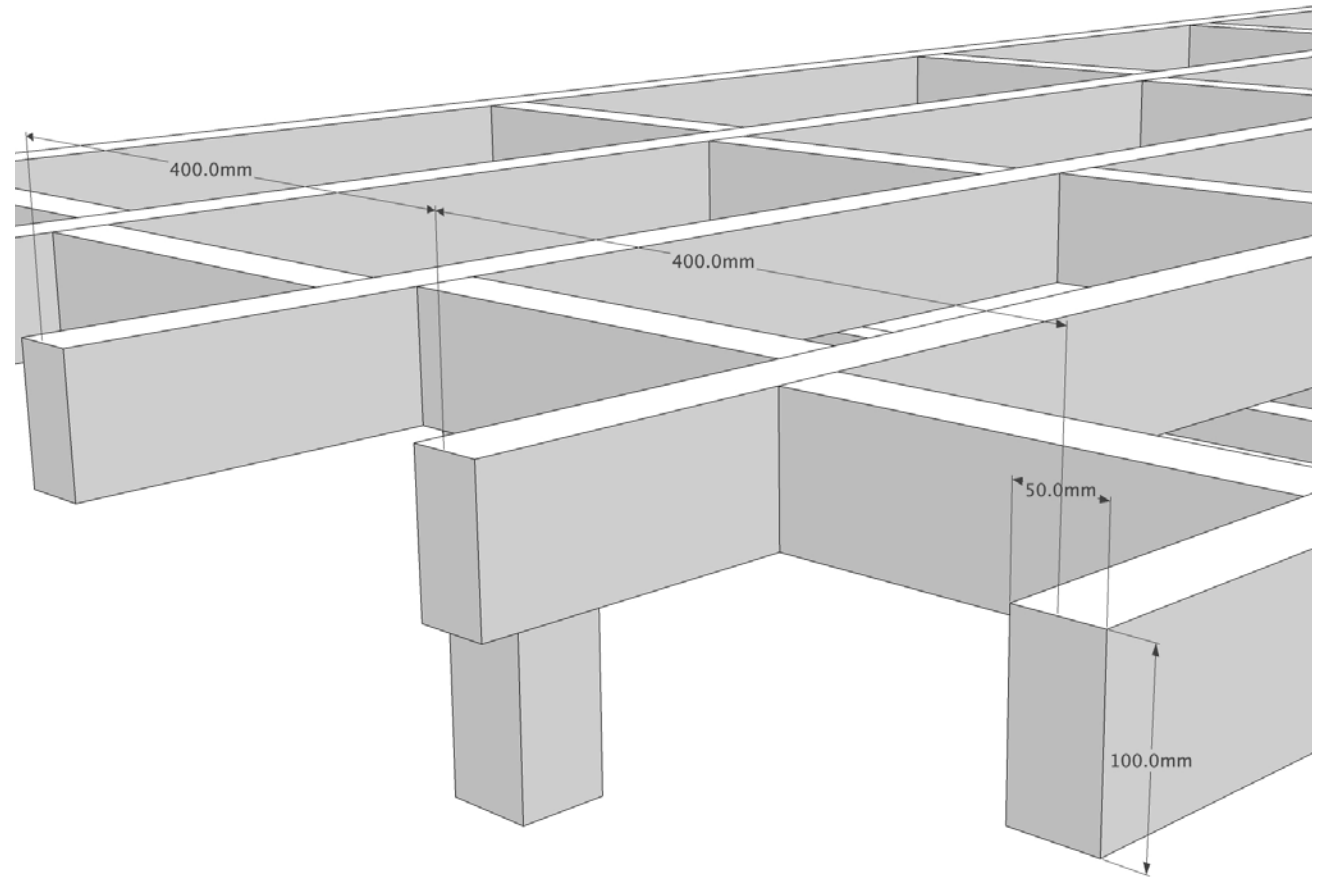

INSTALLATION OF SUBSTRUCTURE

ALUMINIUM OR PLASTIC JOISTS WITH PEDESTAL SYSTEM

These can be fixed to:

- Adjustable Pedestals:
 - With solid flat foundations and flat roof areas the decking substructure can be supported with adjustable support pedestals. These are simply placed straight onto flat roofs or hard standing and the height of each is adjusted by rotating the pedestal top. 6-7 no: recommended per m2 (depending on detailing).
- Solid plastic posts (100x100mm)
- Concrete blockwork or low walls.

Please contact our technical team for further information.

TYPICAL ALUMINIUM / PLASTIC SUB-FRAME ON ADJUSTABLE PEDESTALS

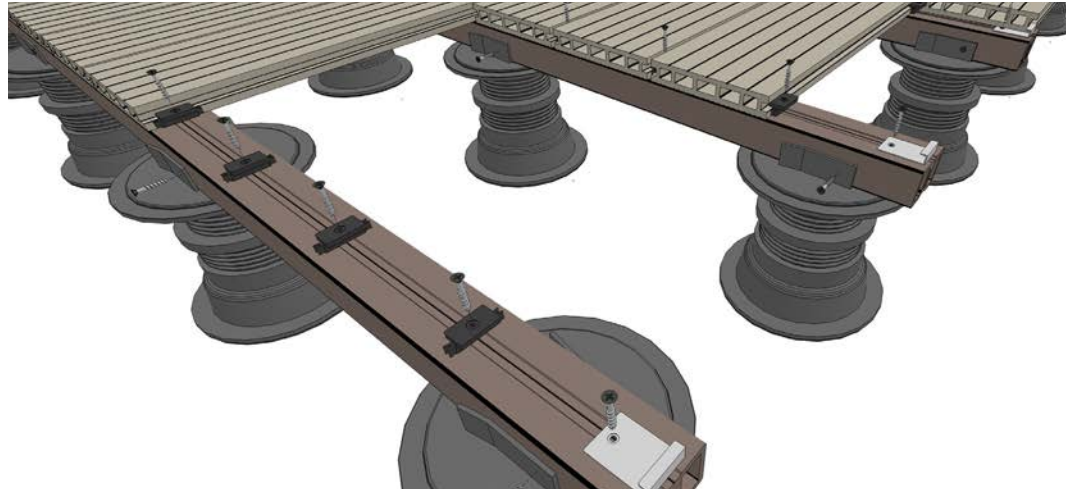

TYPICAL ALUMINIUM / PLASTIC SUB-FRAME ON SOLID PLASTIC POST

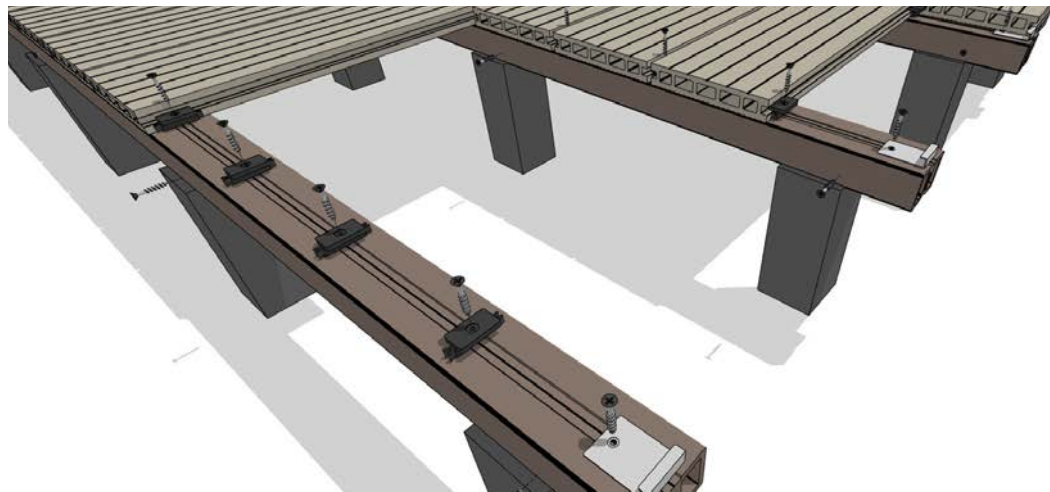

INSTALLATION

STEP 1

ORIENTATION OF DECKING BOARDS

A We recommend that decking boards are laid perpendicular to the direction of the sub-frame, however other configurations are possible.

Decking boards also function and look best when laid perpendicular to building line / door / viewing point.

There are a wide variety of laying patterns that can be achieved but these are not covered in this manual. Ecoscape are able to assist with the design of non standard laying patterns.

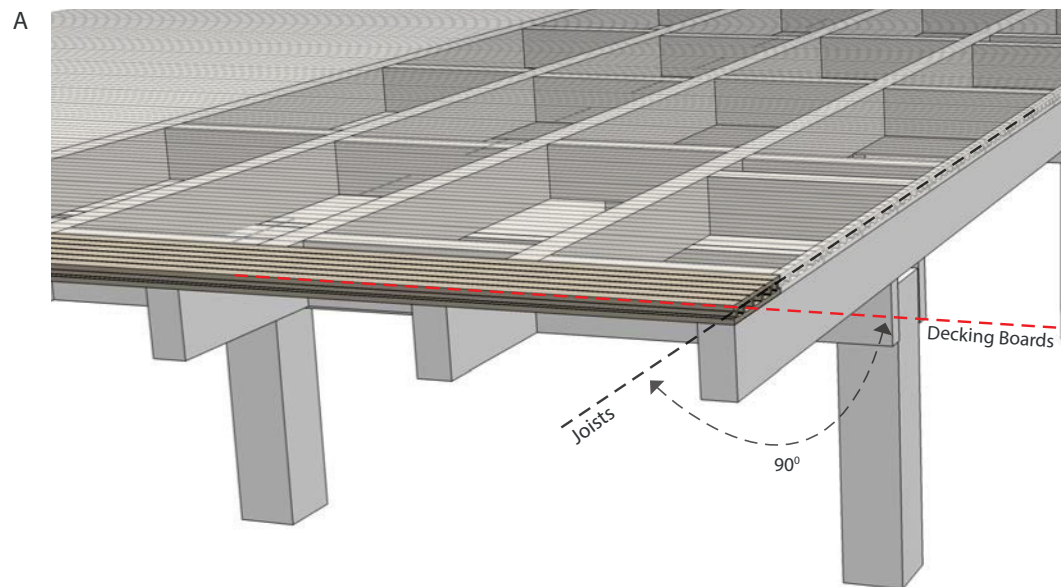

INSTALLATION

STEP 2

FIXING THE STARTER CLIPS

- B Once you have determined the location and orientation of the first decking board, you are ready to install the first starter clip. Align the clip to the end and centre of the joist, pre-drill, and screw the starter clip in place using the starter clip screw.

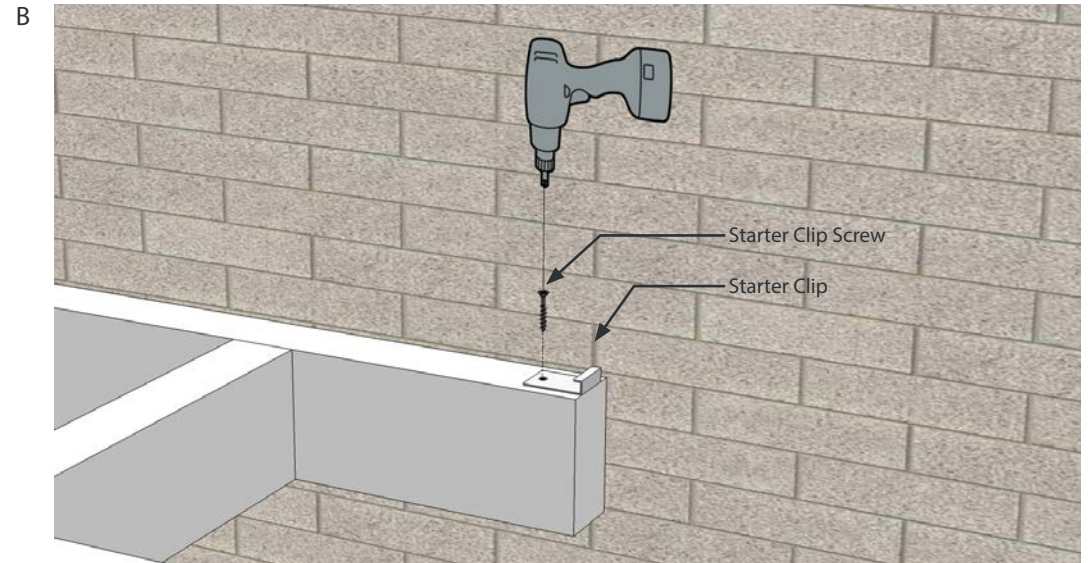

- C Using a deck board or string line install the remaining starter clips, taking care to ensure they are aligned

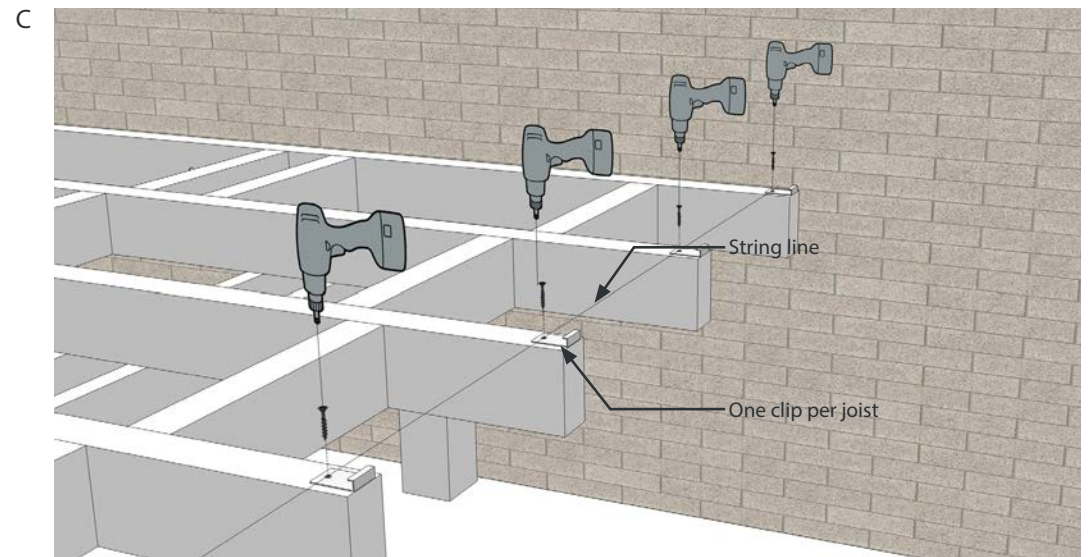

INSTALLATION

STEP 3

INSTALL THE FIRST DECKING BOARD

- D Take the first board and slide it into the starter clip using the grooves in the side of the board.

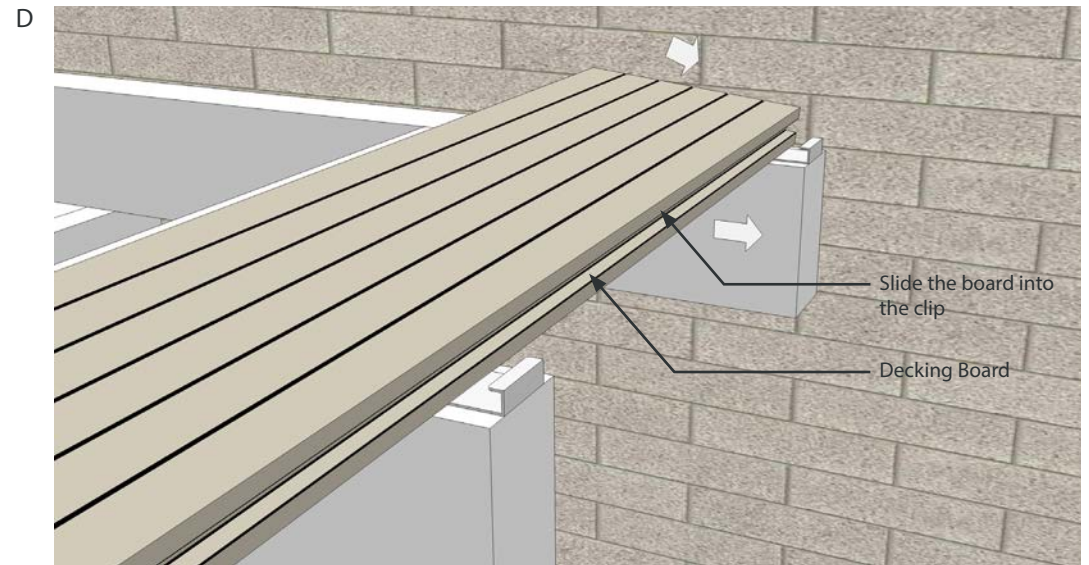

- E Ensure the board is fully installed into the clip before proceeding.

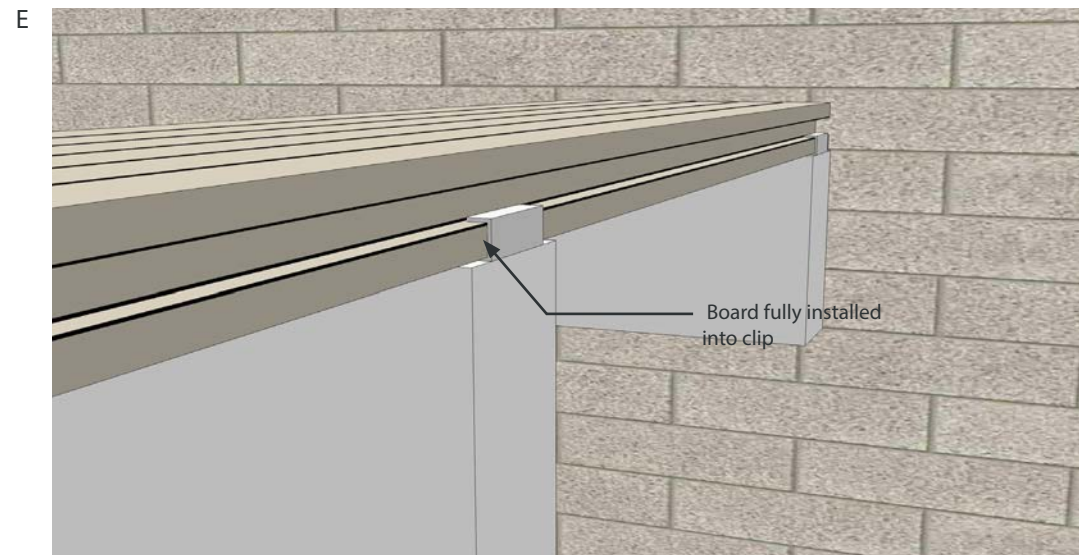

INSTALLATION

STEP 4

INSTALL THE T-CLIPS

- F Using the Hidden T-Clips, Secure one end of the board in place by sliding the T-Clip into the side groove on the decking board and part screwing the T-Clip screw into the joist. Do not fully screw the T-Clip in place.

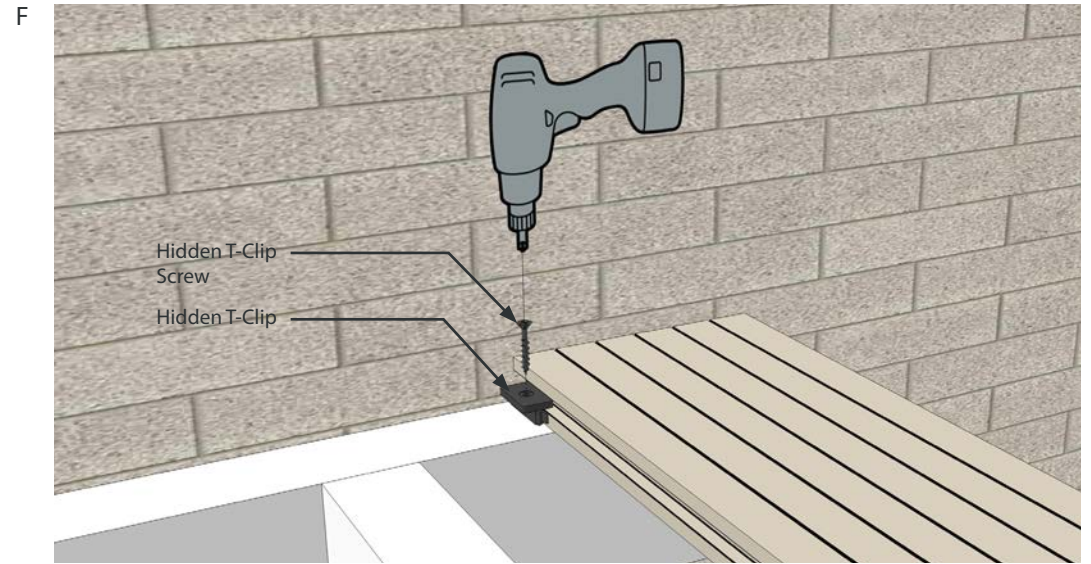

- G Install the remaining T-Clips part way as above. One T-Clip should be installed per joist.

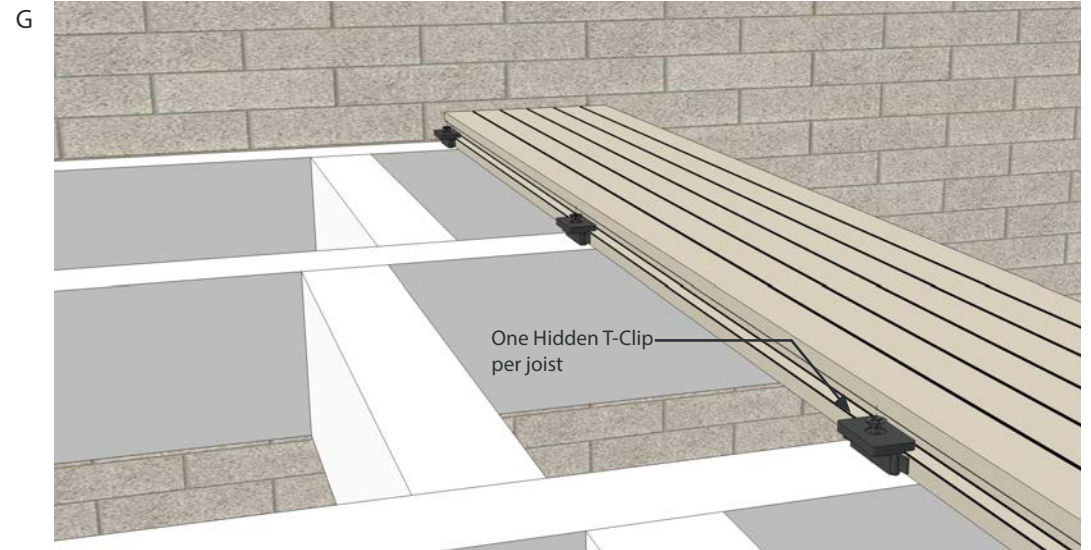

INSTALLATION

STEP 5

INSTALL THE LOCKING CLIP

- H B+M also offer a Locking clip. This is a similar profile to the T-Clip but with serrated teeth which lock the board in place. This ensures even expansion or contraction during hot or cold weather.

One Locking clip can be placed to the center of each board where it hits the sub-frame. This will allow for the even expansion and contraction across the board length as shown in the diagram adjacent.

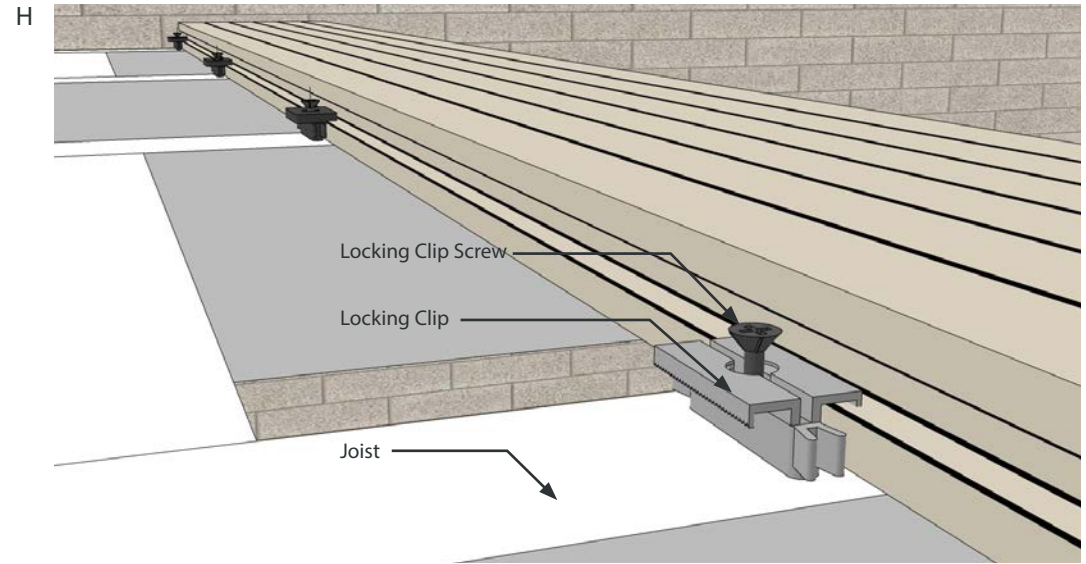

Locking Clip - Plan View

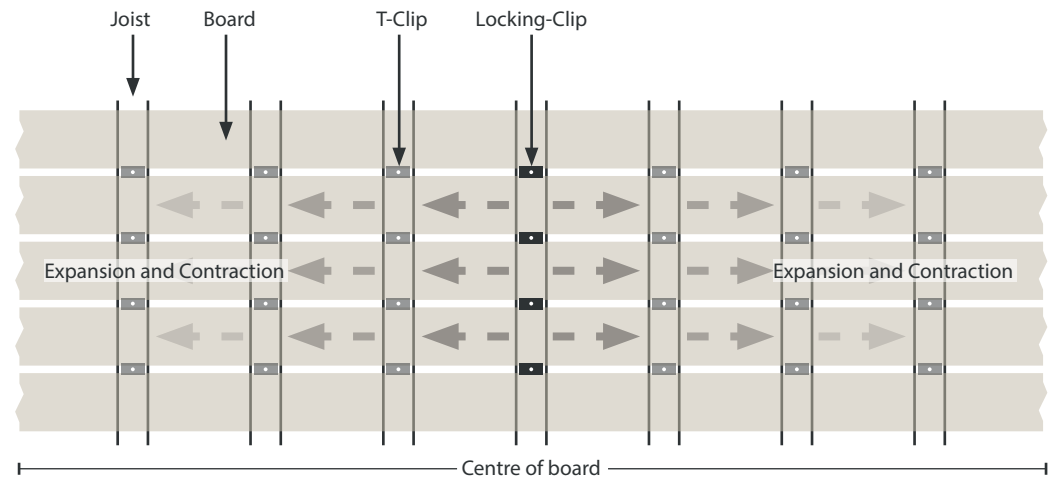

INSTALLATION

STEP 6

INSTALL THE SECOND DECKING BOARD

- I Take the second decking board and slide into the T-Clip fixings

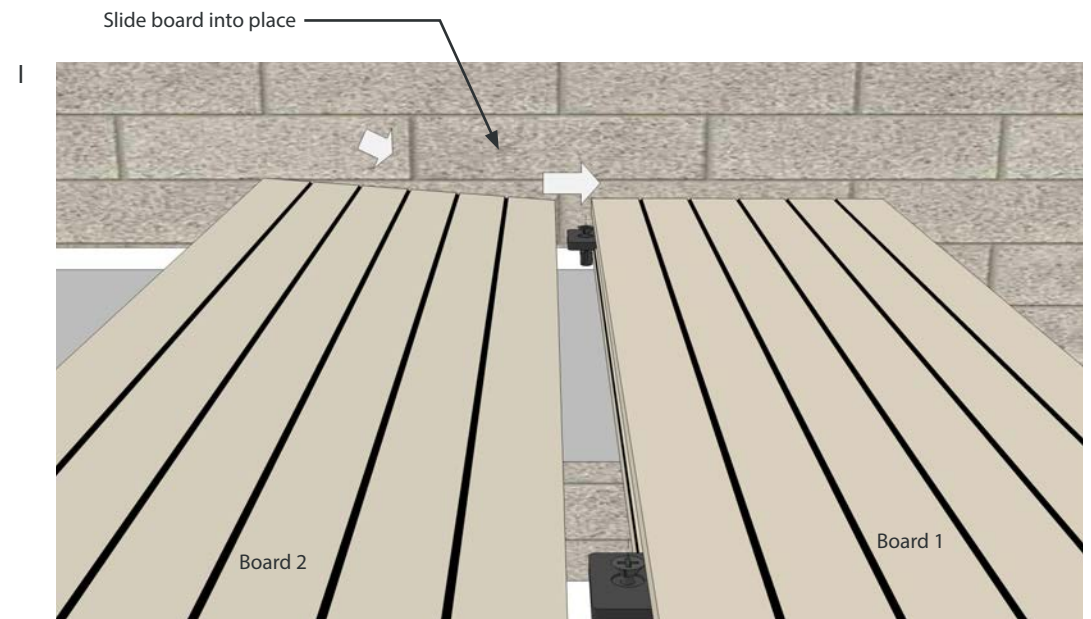

- J Install the next row of T-Clips to board 2 as described in step 4.

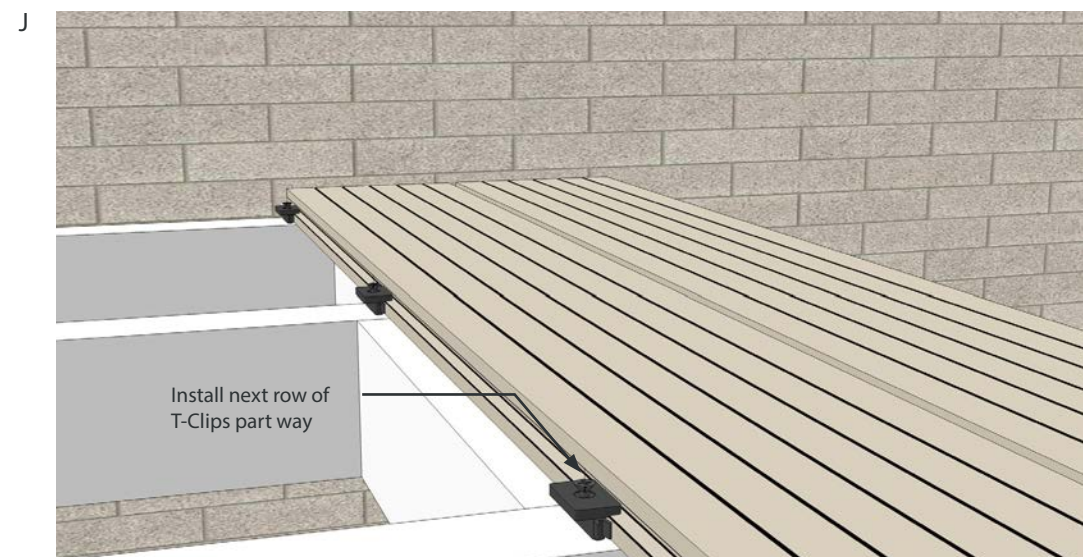

INSTALLATION

STEP 7

FULLY SECURE FIRST SET OF T-CLIPS

- K Once the second board is in place you are ready to fully secure the first line of T-Clips in place.

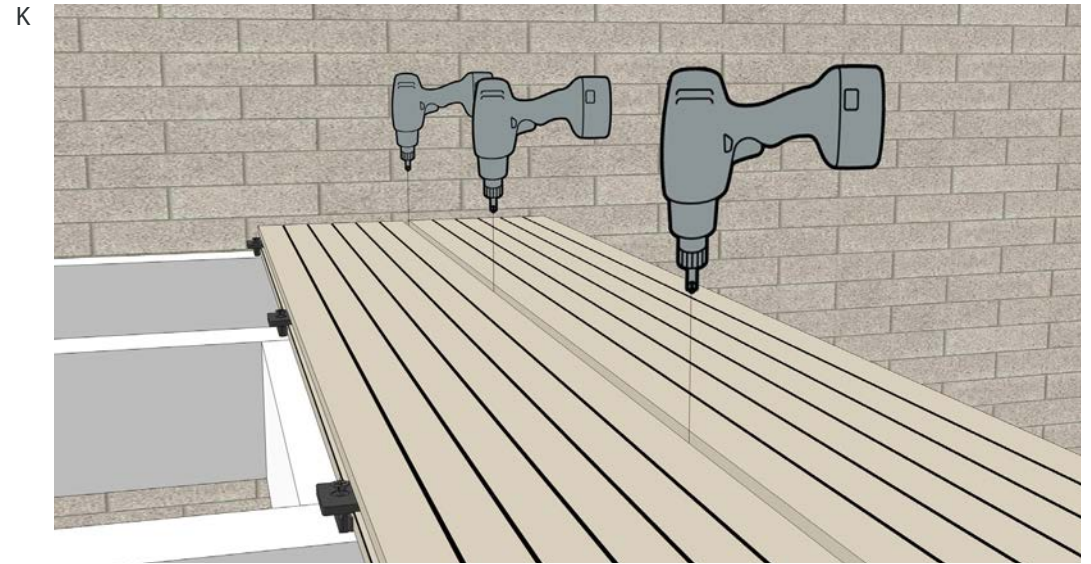

- L When Installing the T-Clips Take care to use a screw bit of a suitable width to avoid damage to the boards.

Note - B+M supply the T-Clips with a dedicated screw drill bit. If you are using a drill to install the boards, please ensure you use this. Also take care to ensure the drill chuck does not come in contact with the boards as this may cause damage.

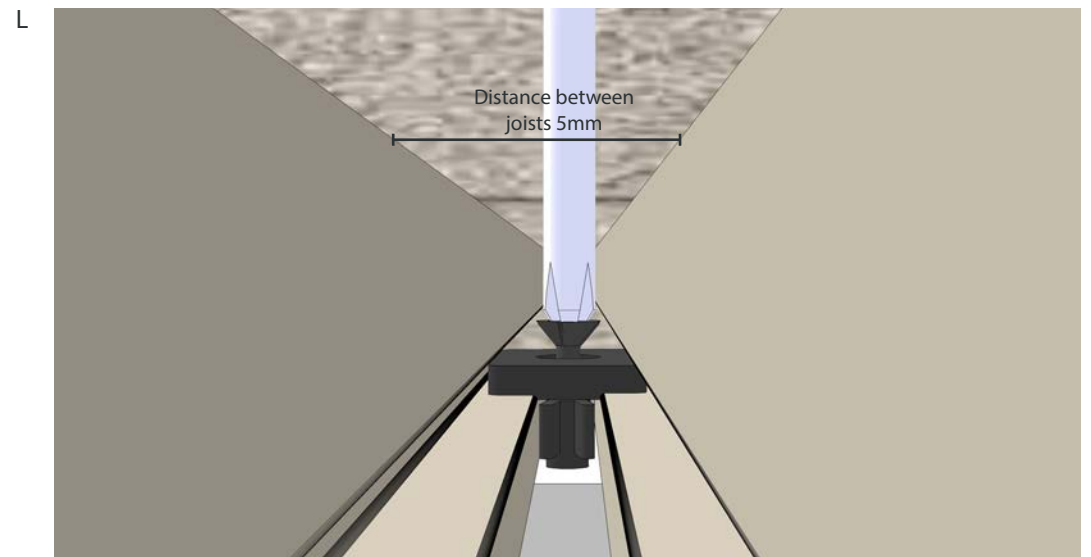

INSTALLATION

STEP 8

INSTALL THE REMAINING BOARDS

- M Repeat steps 4 to 7 and install the remaining area of decking. If the decked area requires end joints to boards, plan where you want the joints to be visible. Joints should be made over a double joist as shown in step O.

M

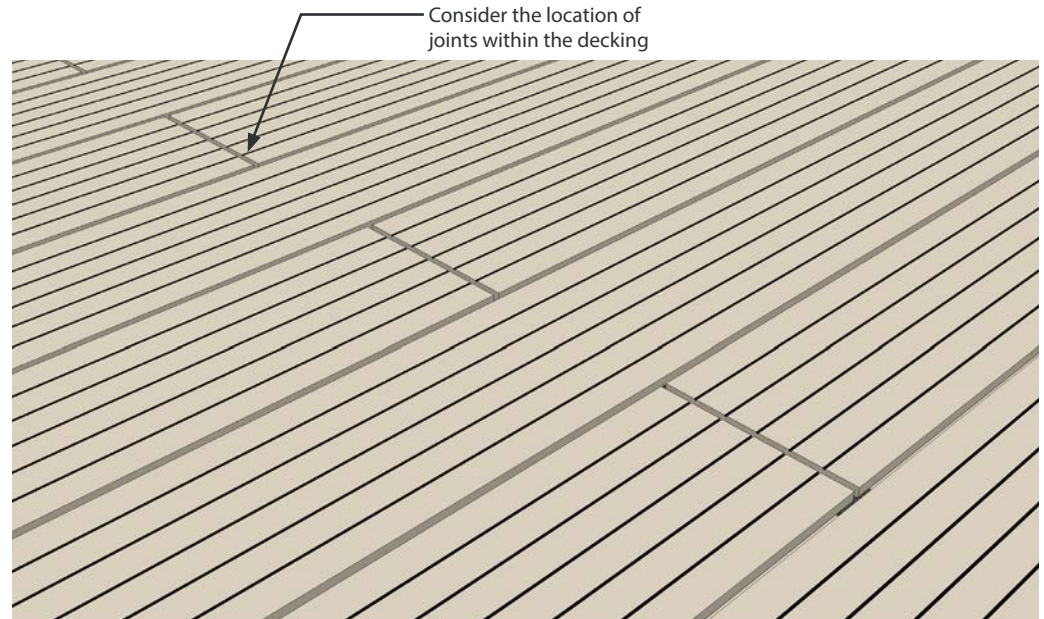

- N Install the remaining boards.

N



INSTALLATION

STEP 9

INSTALLING BOARDS END TO END

- Where a decking board is to be laid end-to-end with another, a 2/3mm gap is to be left between the boards (Gap depends on temperature at time of install - please refer to table, page 34).

Please note - As a product that contains both timber and wood, composite decking is subject to movement with temperature change. The movement is 1mm per 10° C in temperature change of the product, not air temperature. In direct sunlight, darker composites will reach higher temperatures than lighter colours.

Please take into consideration the boards temperature when laying. If particularly warm these may need tighter gaps during install.

The boards should be supported by sub-frame joists, positioned 20mm apart as shown on the adjacent image. This allows the ends of the decking boards to be supported, whilst also allowing water to drain freely between the ends of the boards and prevent standing water.

*** Please refer to the table on page 34 when installing the deck boards to determine the gap (mm) between boards and adjacent structures.

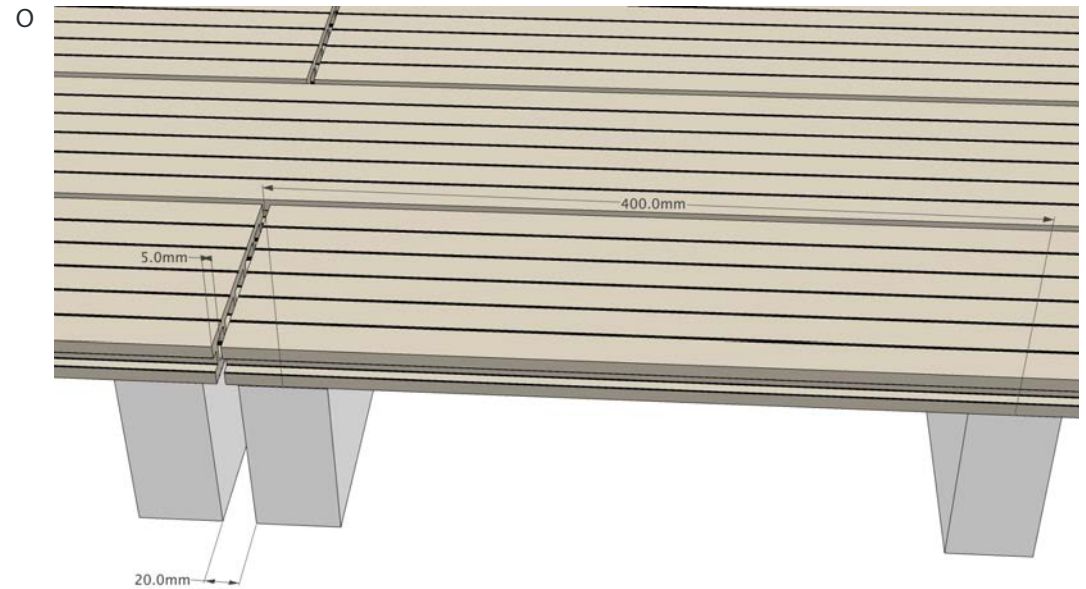

INSTALLATION

STEP 10

INSTALLING BREAKER BOARDS

P Sometimes you may want to install Breaker Boards or create a Picture Frame as shown in Image O. These can be very effective in breaking up the deck area.

These can be fitted either by;

- Cutting down T-Clips - Refer to step Q , or;
- Using Starter clips - refer to Step R

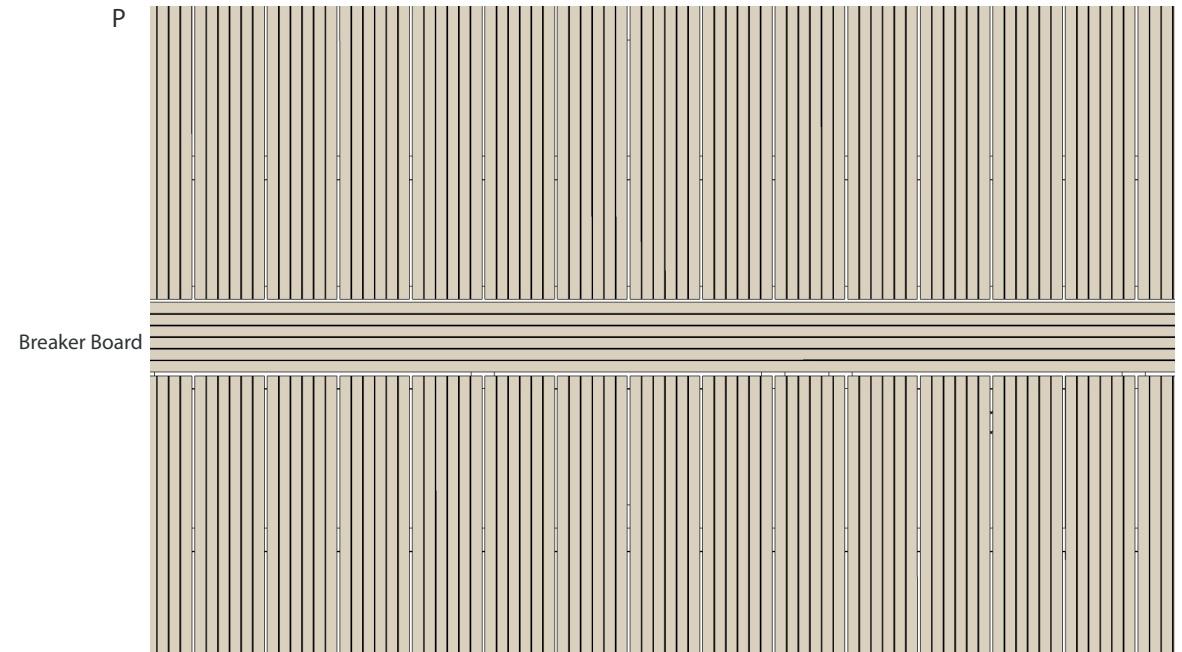

INSTALLATION

STEP 10

INSTALL BREAKER BOARDS - USING T-CLIPS

Q To install a breaker board using the T-Clips simply cut one side of the T-Clip off so the end of the adjoining board can sit tight.

Cutting the T-Clip

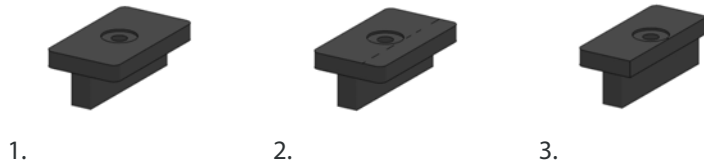

Note - Breaker boards should be fitted with a double joist support as illustrated in the adjacent images. This will ensure sufficient support to both the breaker board and the adjoining board end.

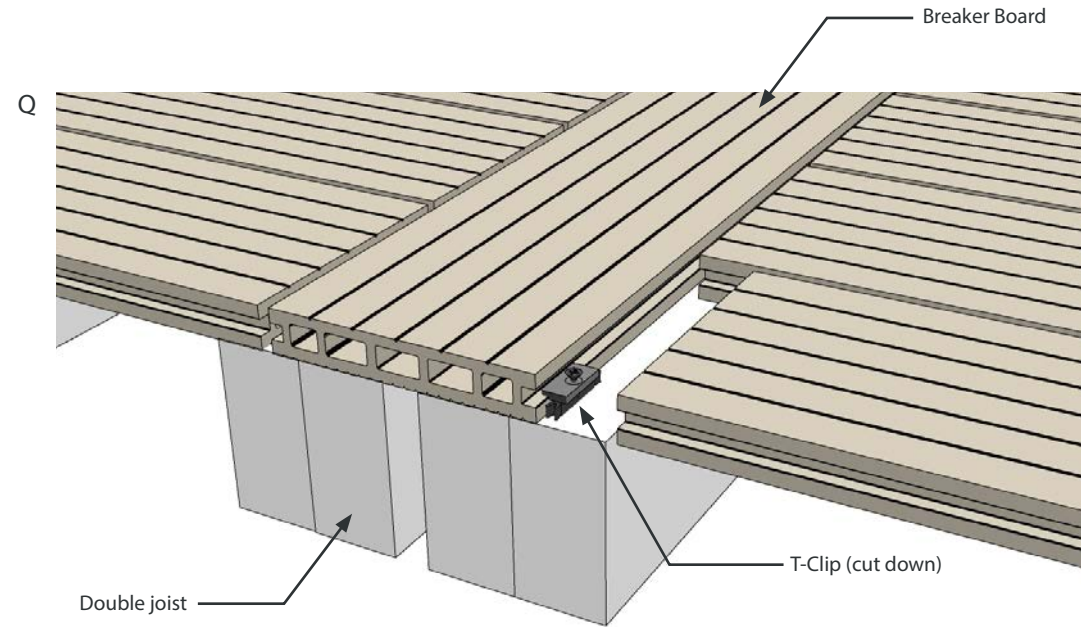

Breaker Board - T-Clip - Plan View

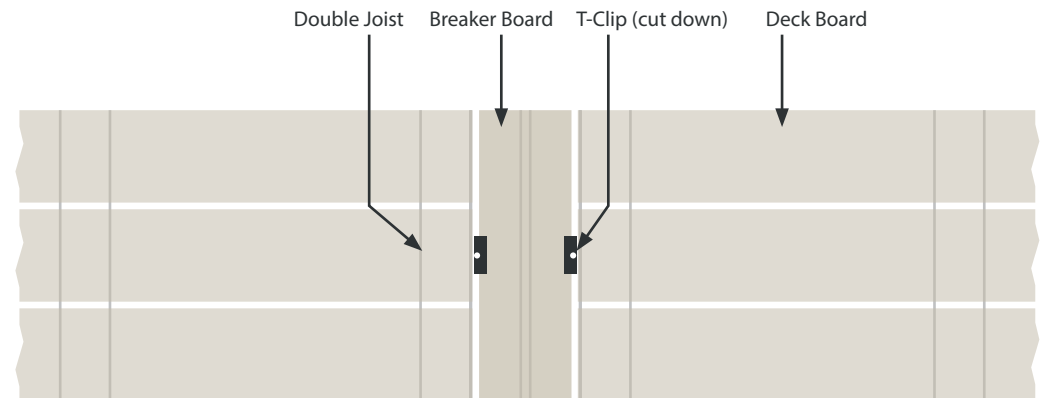

INSTALLATION

STEP 10

INSTALL BREAKER BOARDS - USING STARTER CLIPS

R To install a breaker board using the Starter Clips install the starter clips as per step 2 and 3.

Note - Breaker boards should be fitted with a double joist support as illustrated in the adjacent images. This will ensure sufficient support to both the breaker board and the adjoining board end.

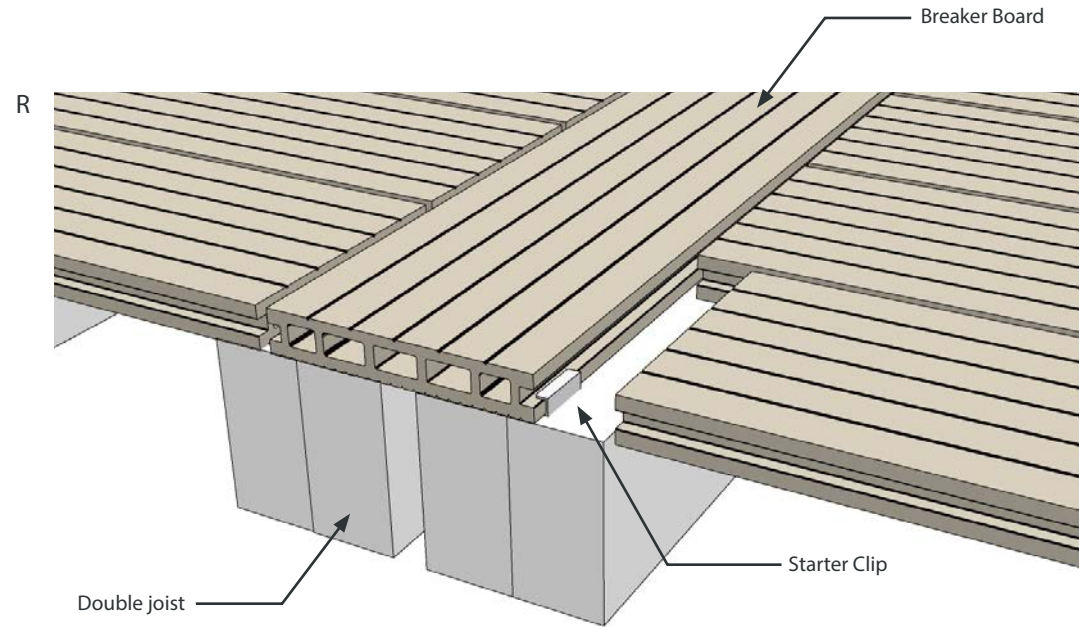

Breaker Board - Starter Clip - Plan View

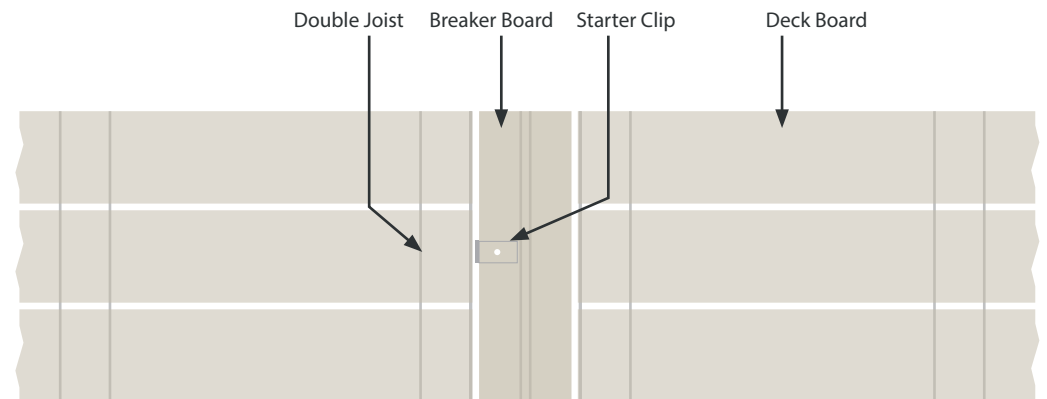

INSTALLATION

STEP 11 (FINISHING THE DECK)

OPTION 1 - 10x150mm FASCIA BOARD

S Once the main boards have been installed the fascia trim can be attached to create a clean edge.

Align the first Trim with the top edge of the decking and fix into the joists using the colour coded screws. 2 screws per joist (every 400mm).

Screws should be per-drilled and counter sunk for the perfect finish and to stop cracking.

Cont. Next page.

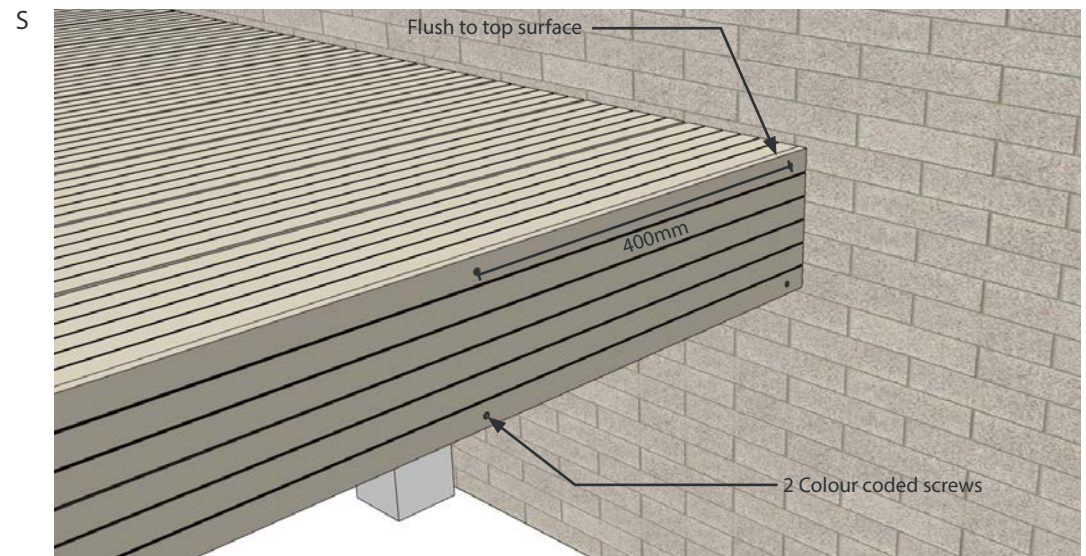
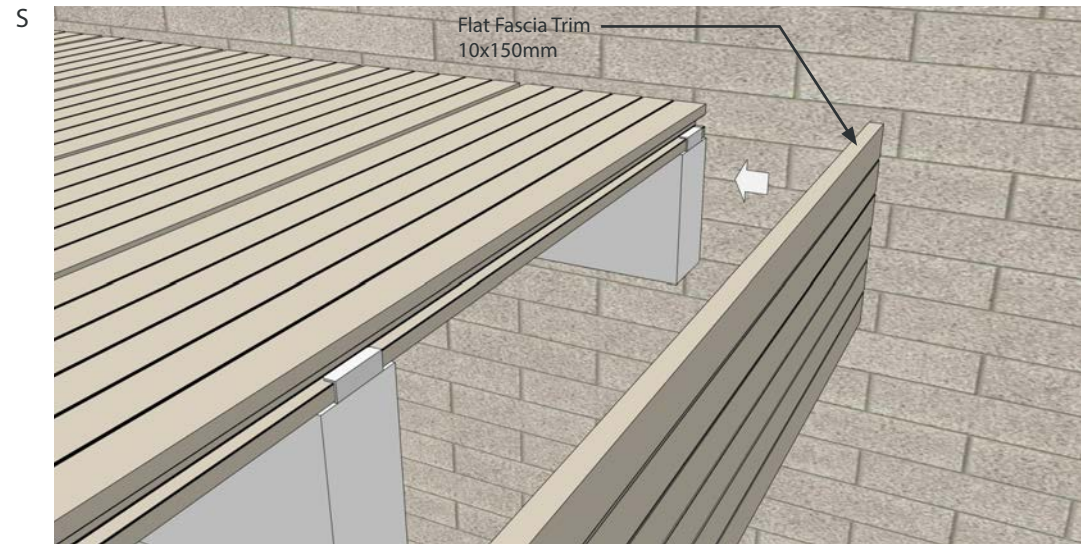

INSTALLATION

STEP 11 (FINISHING THE DECK)

OPTION 1 - 10x150mm FASCIA BOARD

T Use the flat fascia boards to finish the sides of the decking as required

T

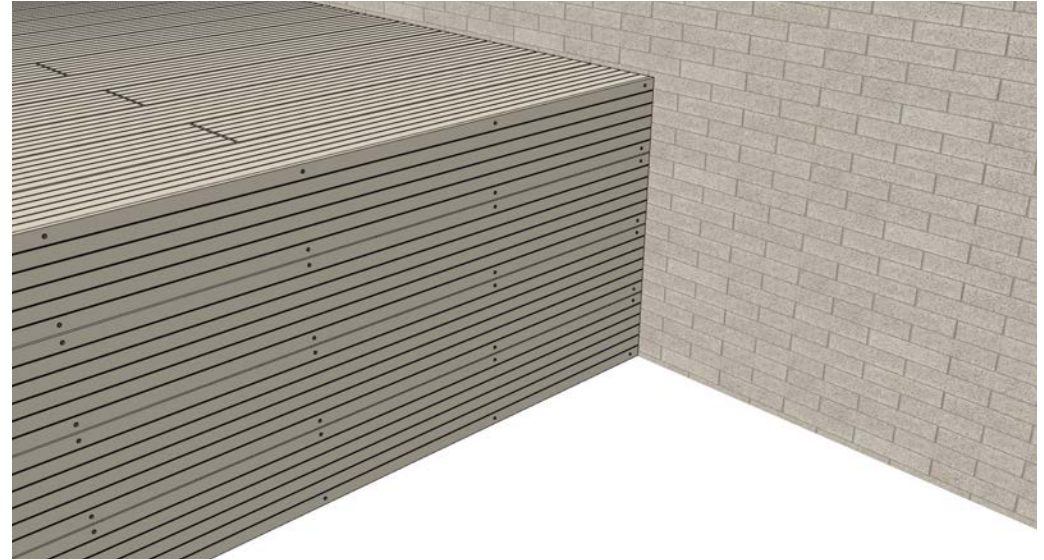

INSTALLATION

STEP 11 (FINISHING THE DECK)

OPTION 2 - ANGLE TRIM

- U An alternative method to finishing the decking is to utilise additional decking boards to clad the face of the decked area. The boards should be installed in a similar manner to the decking, however countersunk screws can be used rather than Hidden T-Clip fixings if the face of the decking isn't going to be in view.

Cont. next page.

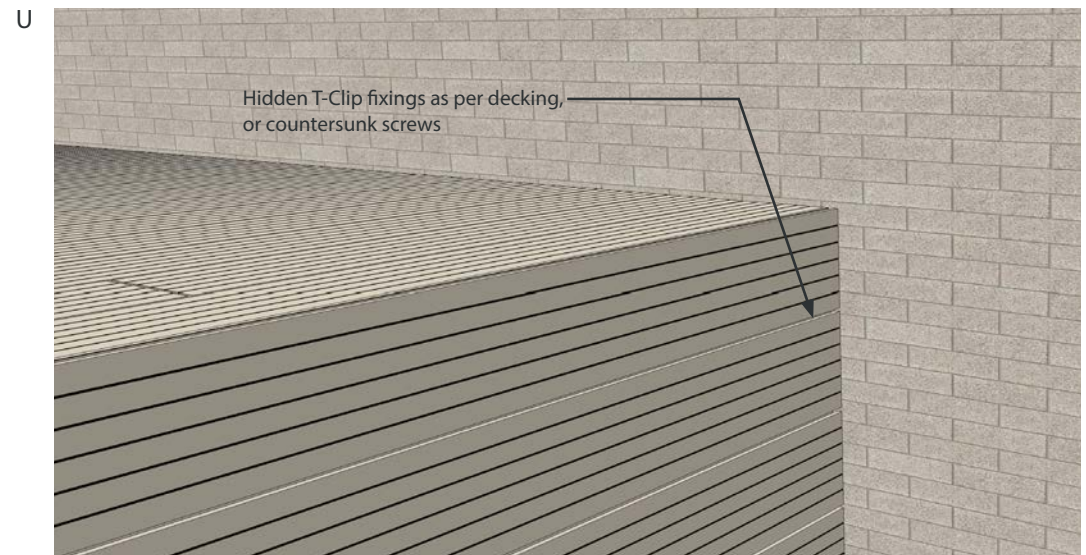

INSTALLATION

STEP 11 (FINISHING THE DECK)

OPTION 2 - ANGLE TRIM

V Once the decking boards have been installed to the face, the Angle Fascia Trim accessory can be pinned to the top edge of the decking using colour coded screws or poly pins, creating a smooth join.

1 screws or pins per joist (every 400mm). Screws should be pre drilled and counter sunk for the perfect finish and to stop cracking.

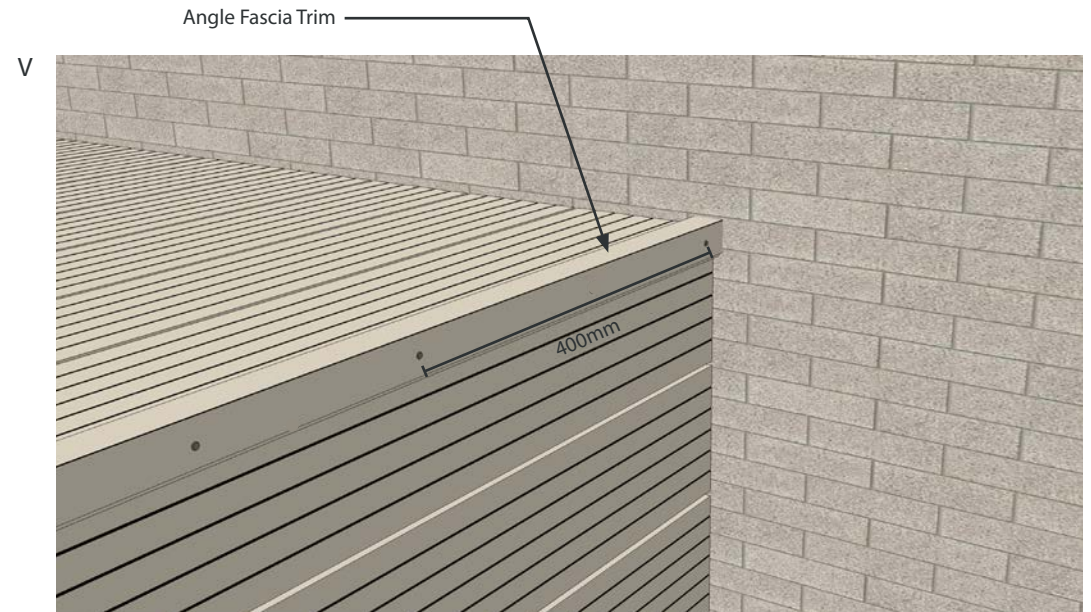

INSTALLATION

STEP 11 (FINISHING THE DECK)

OPTION 3 - STEP BOARD FLUSH

W A third method is to finish the decking utilising the step board to top edge - This method achieves a seamless finish with no fixings on show.

If this method is chosen, it is best to begin the decking process with the finishing boards to achieve a flush finish

W.1 - Fix the starter fixings into the frame. Note that this will determine how much the board over hangs the edge of the deck. Align the step board and push down over the starter clip.

W.2 - Push the step board forwards so it slides into the starter clip.

W.3 and W.4 - Fix the adjoining decking boards to the deck and fascia using the T-Clips, Starter and Locking clips as required.

Continue with the rest of the decking.

W.1

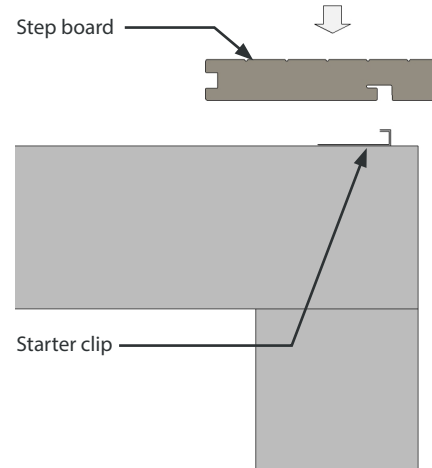

W.2

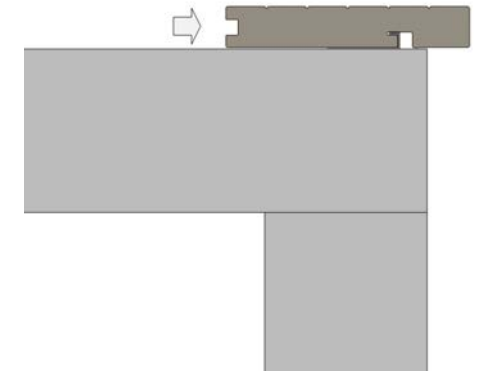

W.3

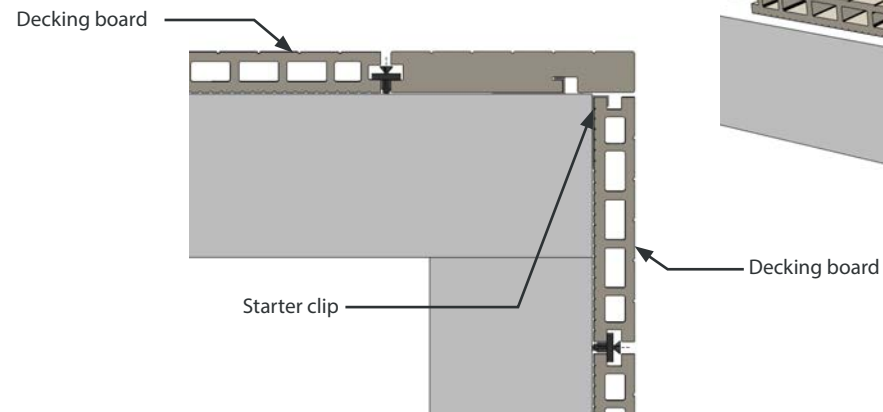

W.4

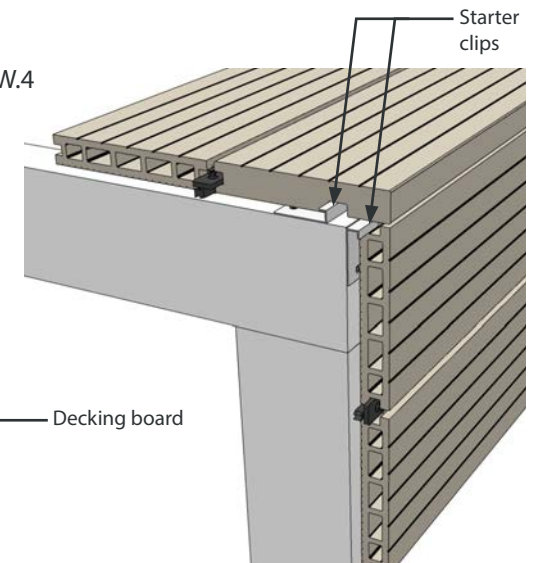

INSTALLATION

STEP 11 (FINISHING THE DECK)

OPTION 4 - STEP BOARD 15mm OVERHANG

X Alternatively, you can install a step board as per option 3, but with a small overhang to the top edge. This is particularly effective when using the step board on steps.

If this method is chosen, it is best to begin the decking process with the finishing boards to achieve the correct overhang to the edge

X.1 - Fix the starter fixings into the frame. Note that this will determine how much the board overhangs the edge of the deck. Align the step board and push down over the starter clip.

X.2 - Push the step board forwards so it slides into the starter clip.

X.3 and X.4 - Fix the adjoining decking boards to the deck and fascia using the T-Clips, Starter and Locking clips as required.

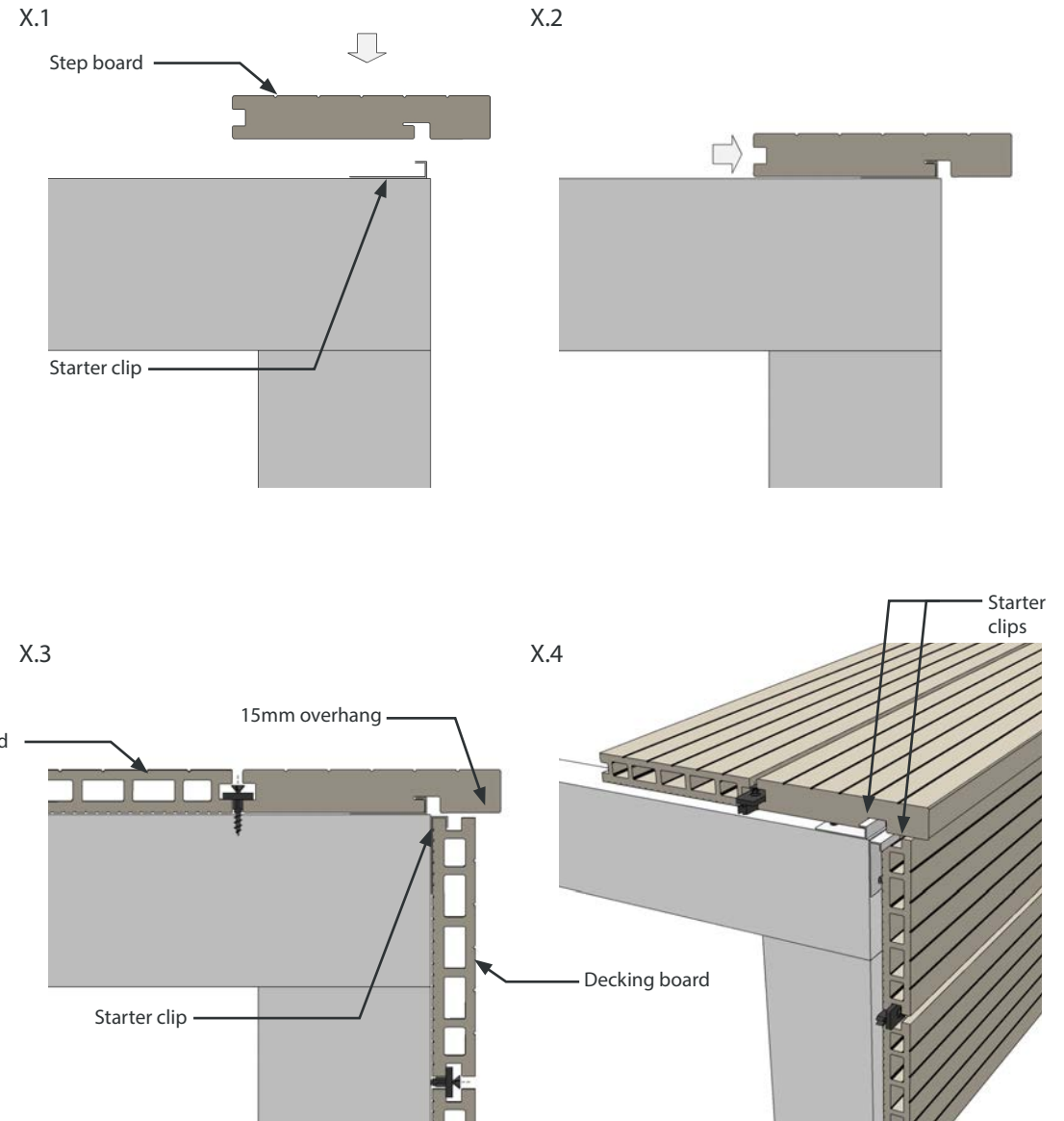

INSTALLATION

STEP 12 (FINISHING THE DECK)

INSTALL REMAINING BOARDS

Y Once all the boards are installed the jointing should be seamless

Y

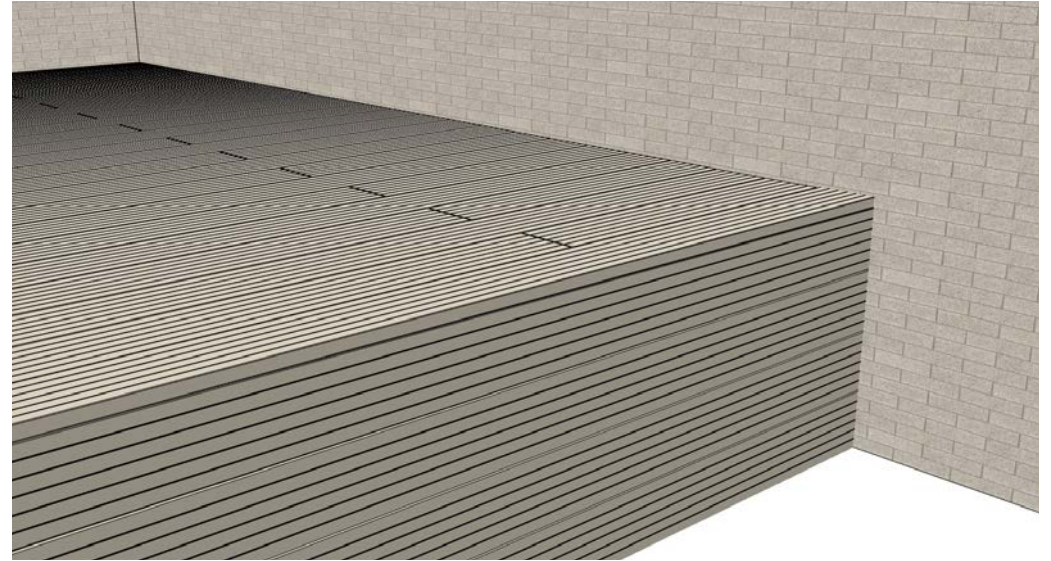

INSTALLATION END

Z Job Done!

Please consult with the technical department for further advice.

Z



CLEANING AND CARE

HomeDeck Decking boards will require periodic maintenance to remove the build up of dirt and debris. We recommend the decking is cleaned once or twice a year using either:

- A high pressure cleaner (Jet wash) with a fan shaped beam at a distance of at least 20cm in a lengthwise direction, or;
- Scrubbing brush with a all-purpose cleaner and water

Burn marks, from BBQ's or similar can also be removed using a coarse piece of sandpaper (80gsm or similar), by rubbing the deck lengthways gently.

EXPANSION GAP TABLE

Please refer to the table below when installing the deck boards to determine the gap (mm) between boards and adjacent structures.

Please note this table covers expansion and contraction values for UK, Europe

		Length (Meters)									
		1	2.44	2.8	3	3.66	3.9	4	4.88	5.4	
Installation Temperature (°C)	-10	2.4	5.9	6.7	7.2	8.8	9.4	9.6	11.7	13.0	Gap (mm)
	-5	2.2	5.4	6.2	6.6	8.1	8.6	8.8	10.7	11.9	
	0	2.0	4.9	5.6	6.0	7.3	7.8	8.0	9.8	10.8	
	5	1.8	4.4	5.0	5.4	6.6	7.0	7.2	8.8	9.7	
	10	1.6	3.9	4.5	4.8	5.9	6.2	6.4	7.8	8.6	
	15	1.4	3.4	3.9	4.2	5.1	5.5	5.6	6.8	7.6	
	20	1.2	2.9	3.4	3.6	4.4	4.7	4.8	5.9	6.5	
	25	1.0	2.4	2.8	3.0	3.7	3.9	4.0	4.9	5.4	
	30	0.8	2.0	2.2	2.4	2.9	3.1	3.2	3.9	4.3	
	35	0.6	1.5	1.7	1.8	2.2	2.3	2.4	2.9	3.2	
	40	0.4	1.0	1.1	1.2	1.5	1.6	1.6	2.0	2.2	

REMOVING A BOARD

DECKING BOARD

AA Start by unscrewing all the T-Clips that attach the board on both sides.

AA

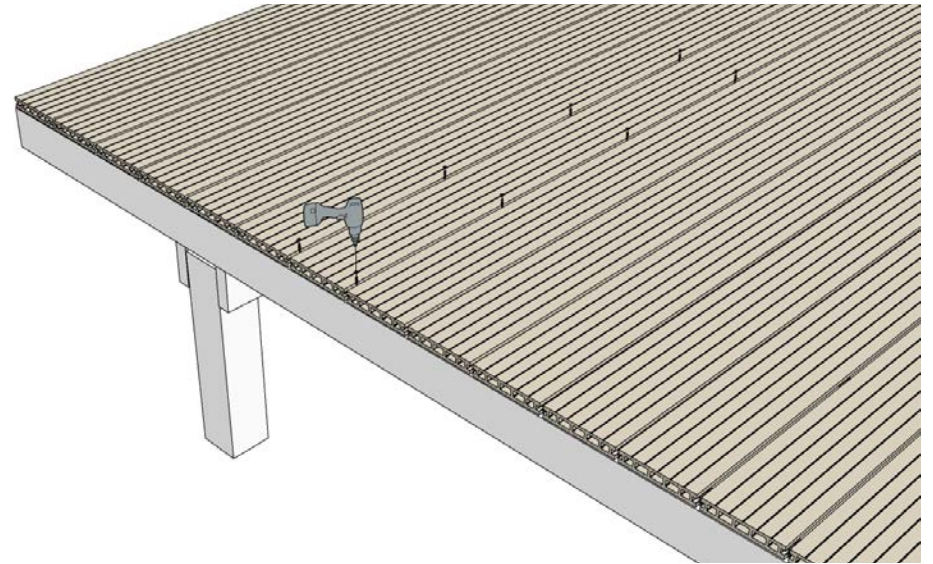

BB Then slide all the T-Clips out of the board.

BB

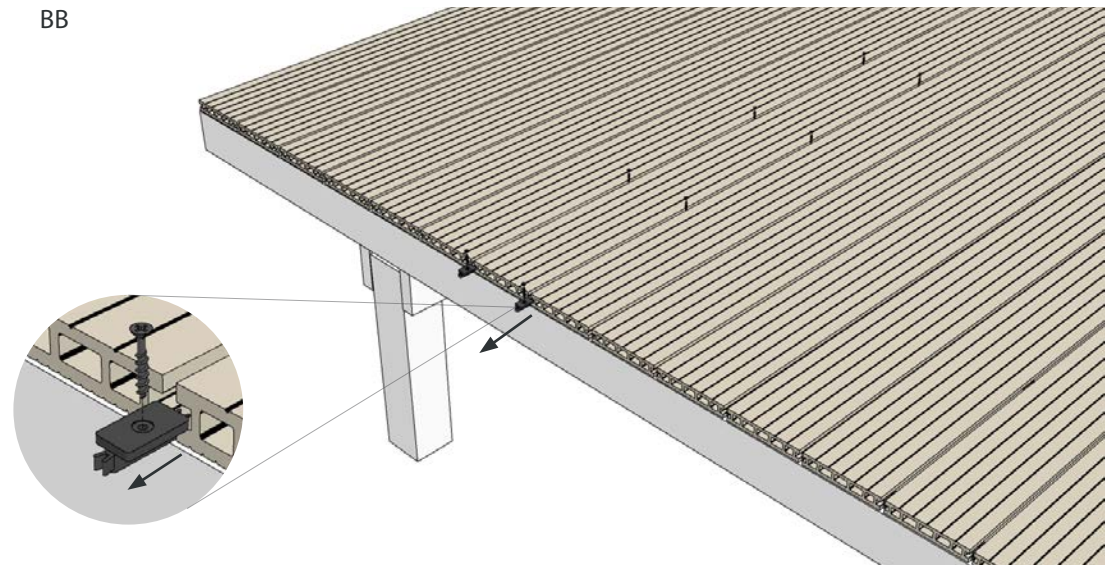

REMOVING A BOARD

DECKING BOARD

CC Slide out the decking Board

CC

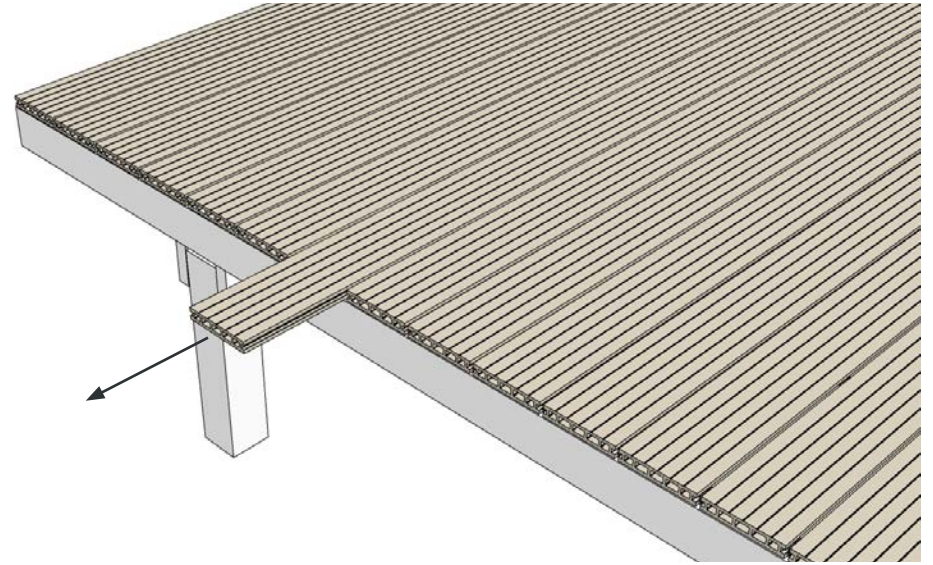

DD The new board can now be inserted. Take the opportunity to check the sub frame for any damage / wear.

DD

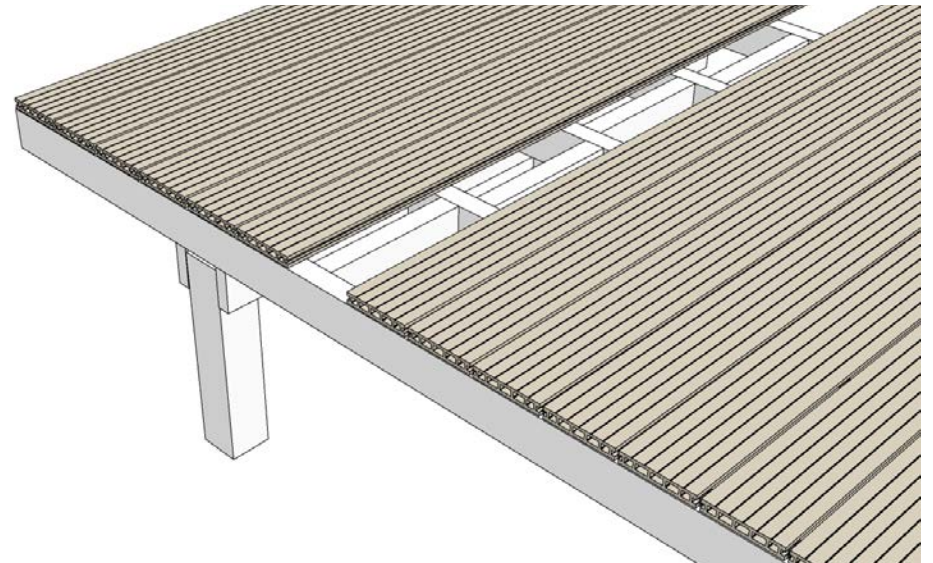

REMOVING A BOARD

DECKING BOARD

EE Slide the new board into position.

EE

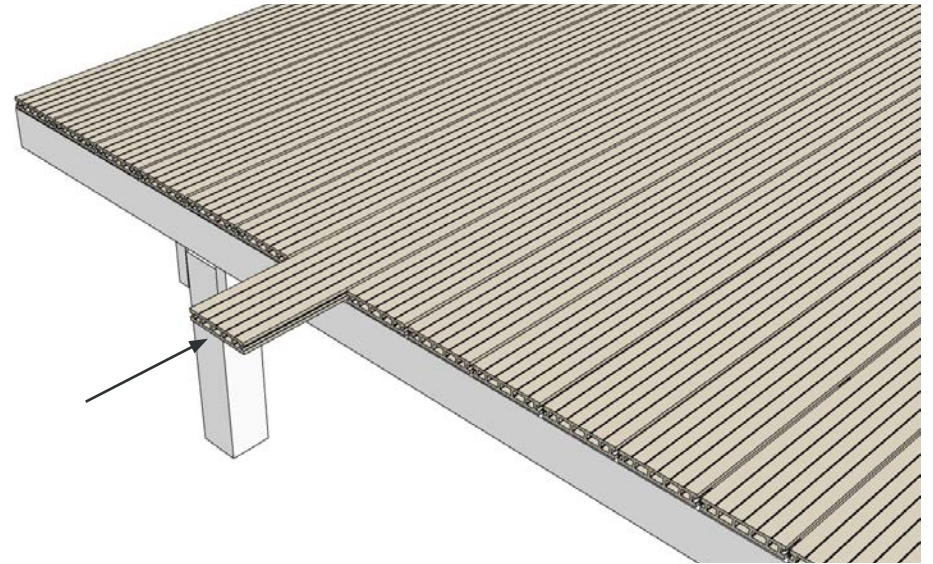

FF Then slide all the T-Clips back into the grooves of the board, and back into their original positions.

FF

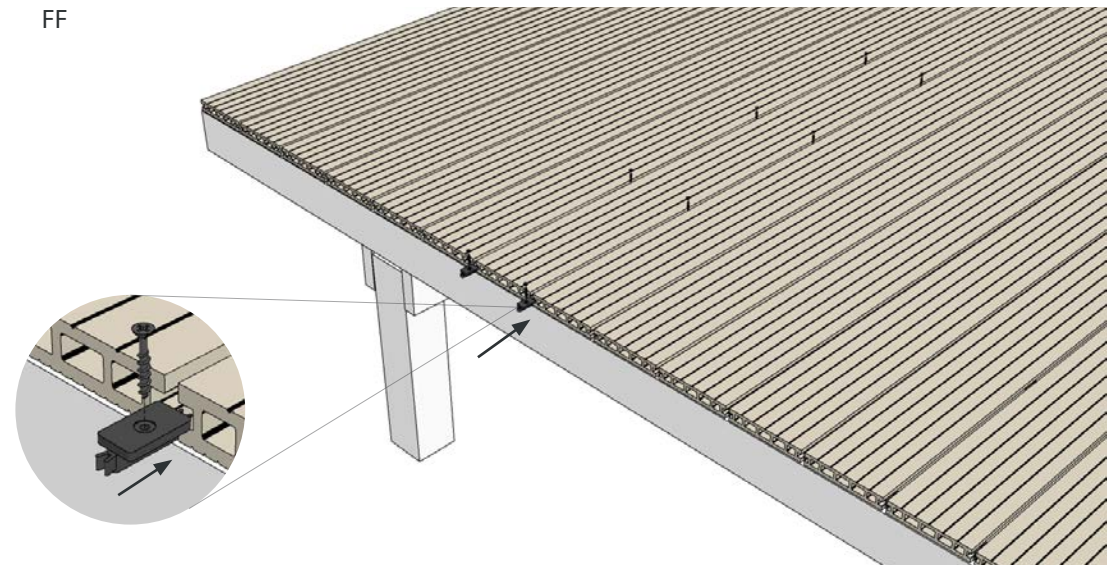

REMOVING A BOARD

DECKING BOARD

GG The clips can then be re-secured

GG

